



SWITCH TO BRIGHTER FUTURE

Product data sheet: MINIU-3.6-350

Features

- Super compact design for built-in use
- Analogue flicker-free
- Primary and secondary sides come with leads
- Protections: opencircuit, shortcircuit, overload, overtemperature
- DC input compatible (127-280V DC)
- SELV equivalent
- Suitable for protection class I and II luminaires
- Protection class II

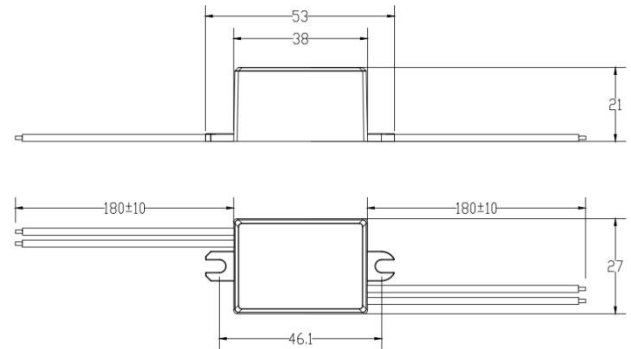

Applications

- Office
- Shop
- Hospitality
- Public areas

Approbations & Certifications

CE

Housing properties

- Housing material: plastic, white
- Type of protection IP20

Electrical Specifications

Type		Unit	MINIU-3.6-350
INPUT	Nominal voltage	V	100 – 240
	Nominal frequency	Hz	50 / 60
	AC voltage range	V	90 – 264
	DC voltage range	V	127 - 280
	Nominal current	A	0.09
	THD (Full load)	%	N/A
	Power factor(Full load)		0.50C
	Efficiency(Full load)	%	71
	Turn on time	ms	≤500
	No load	W	≤ 0.5
	Protection class		II
	Inrush current(Cold start)	A pk	10(th = 300 μs)
	Max.units per circuit breaker		B10:17 B13:23 B16:28 B20:35 C10:37 C13:48 C16: 59 C20:74
	OUTPUT	Nominal voltage range	V
Maximum voltage(Open Circuit)		Vdc	≤17
Nominal current		mA	350
Current accuracy		%	±5
Current ripple ≤120Hz		%	≤50
Pst LM			≤ 1
SVM			≤ 0.4
Nominal power range		W	0.87-3.5
Maximum power		W	3.5
Galvanic isolation			SELV
ENVIRONMENT	Ambient temperature range ta	°C	-20 ...+50
	Maximum case temperature tc	°C	80
	Max. Case temp. In fault condition	°C	110
	Storage temperature range	°C	-20 ...+70
	Relative humidity	%	5 ... 85(Not condensing)
	Surge transient protection	kV	1 1 (L/N LN/PE acc to. EN 61547 Clause 5.7)
	Environmental rating		Indoor
	IP rating		IP 20
	Mains switching cycles		> 100,000
	Expected lifetime	h	50,000 (0.2% / 1'000 h failure rate)

*All parameters NOT specially mentioned are measured at 230VAC input ,rated current and 25°C of ambient temperature

Protections

Overtemperature

Yes

Overload

Yes

No load

Yes

Short-circuit

Yes

Input overvoltage

Maximum allowed input voltage 264VAC

Output overvoltage

Yes

OUTPUT LOAD vs TEMPERATURE

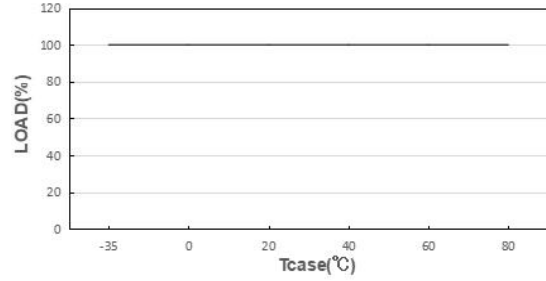
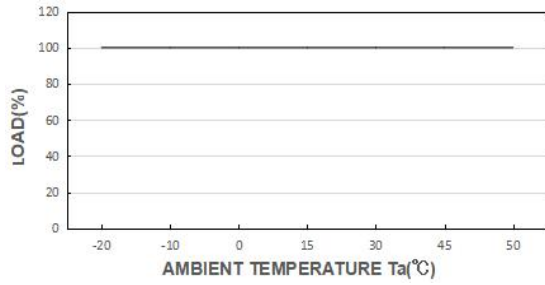

STATIC CHARACTERISTIC

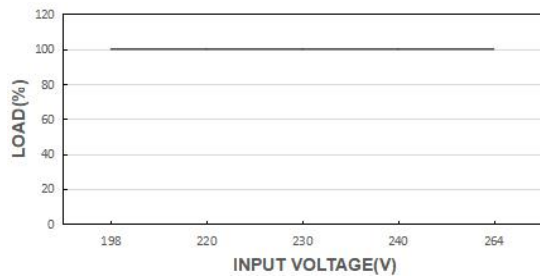

POWER FACTOR (PF) CHARACTERISTIC

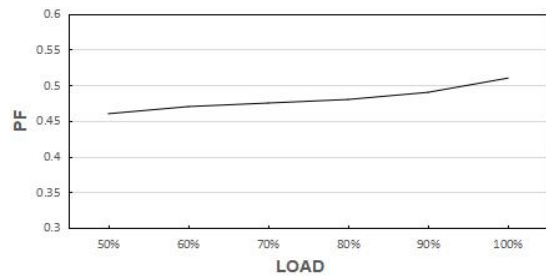

EFFICIENCY vs LOAD

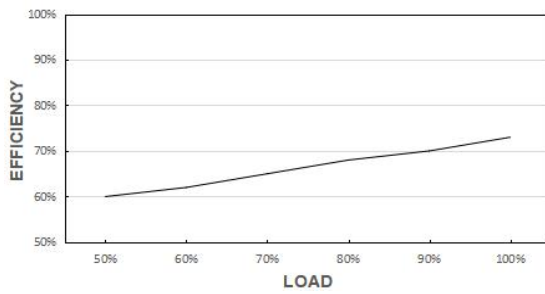

LIFE TIME

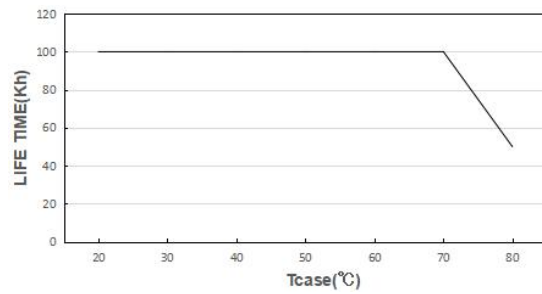

*The graph is for reference only, and the detailed values refer to the parameter table

Wiring Diagram

Max. cable length - system:	2 m
Dimensions(LxWxH):	53 x 27 x 21 mm
Mounting hole spacing, length	46.1 mm
Wire length	180 mm
Weight:	42±5 g

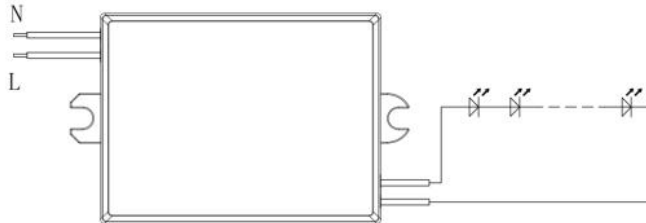

Input wire: VDE 7726 0.5mm²; Output wire: UL 1007 18AWG.

Hot plug-in or secondary switching of LEDs is not permitted and may cause a very high current to the LEDs.

Remarks

-Touch current: lower than 0.7mA, according to EN60598-1annex.G and EN61347-1annexA.

Standards

EN 61347-1
EN 61347-2-13
EN 62384
EN 55015
EN 61000-3-2
EN 61000-3-3
EN 61547
EN 60598-1
EN 50581
IEEE1789
(EU) 2019/2020

Manufacturer's address:

No.4,Tongfu Road,Tong'an Industrial Center,Tong'an District,Xiamen,Fujian,China

www.actec.com